



SMART  
HOME  
LIGHTS

D | Montageanleitung • GB | Fitting instructions

# 832503

230V / 50Hz

2x24 W LED-Board

nicht wechselbar / not changeable

LED



t

Tk



24 W

2.640 Lumen

51 W

3.150 Lumen

LED-Board

25.000 h

2700K-5000K

15.000 x

<0.5s

dimmable with rrc

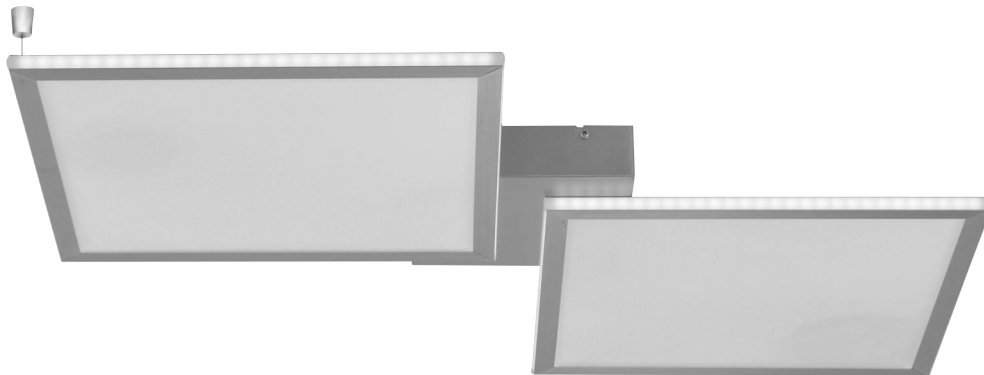
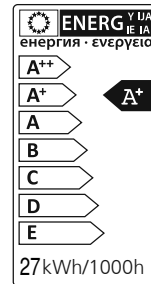

AAA, 1,5V

Inkl. Funkfernbedienung  
Incl. radio remote control



# 1 | Montage / fitting

an Wand oder Decke  
on wall or ceiling

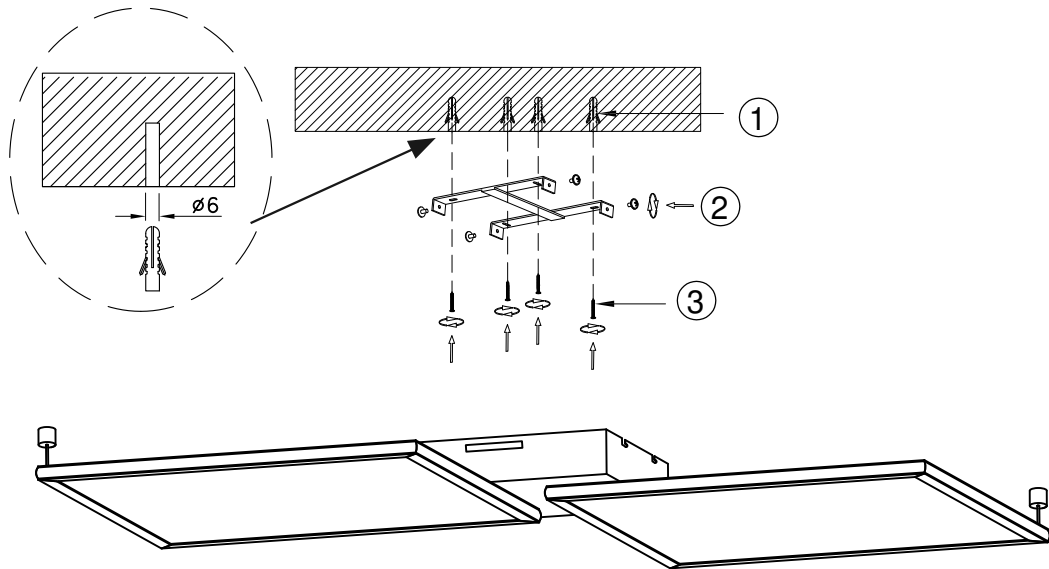

## 2 | Elektrischer Anschluss / electrical connection

230 Volt/50 Hz-Anschluss

230 voltage/50 Hz connection

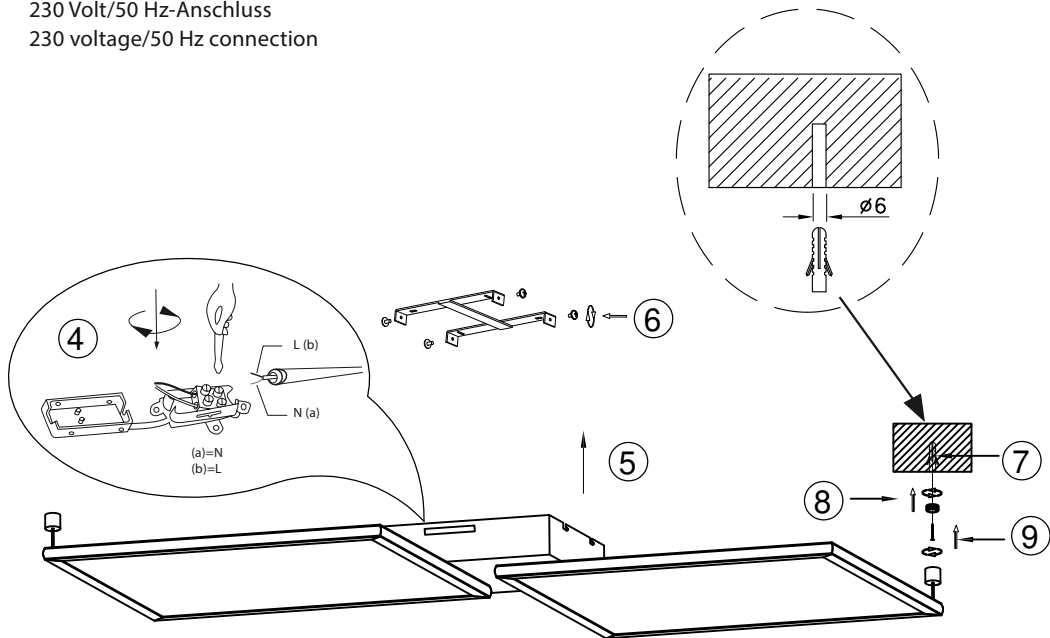

### 3 | Fernbedienung anlernen / teach remote control

Siehe Q-Fernbedienungsanleitung  
See Q-remote control manual

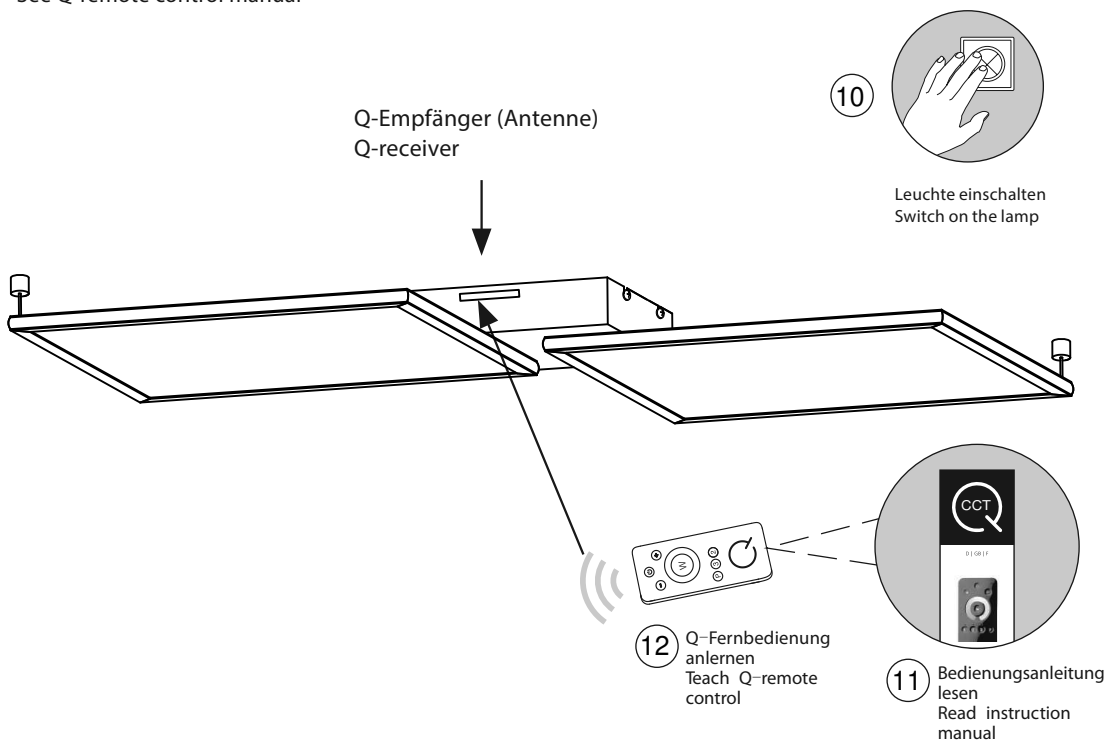



Rückstellen der Leuchte auf Werkseinstellung  
Reset the lamp, factory new

5 x on/off

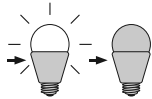

1-2 sec.

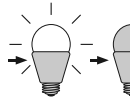

1-2 sec.

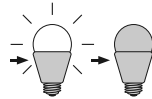

1-2 sec.

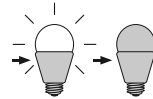

1-2 sec.



Das Gerät erfüllt die grundlegenden Anforderungen der Richtlinie 2014/53/EU (Radio Equipment Directive) des Europäischen Parlaments und des Rates der europäischen Union vom 16.04.2014 über Funkanlagen und die gegenseitige Anerkennung ihrer Konformität.

Die vollständige Konformitätserklärung kann bei der unten angegebenen Adresse angefordert werden.

Bitte geben Sie bei technischen Fragen die Chargennummer (xxxxx-xx-xx-xxxxx-xxx) an. Diese finden Sie auf dem Typenschild der Q-Leuchte.

This device fulfils the fundamental requirements of Directive 2014/53/EU (Radio Equipment Directive) of the European Parliament and of the Council of the European Union dated 16.04.2014 on items of radio equipment and the mutual recognition of their conformity.

The full declaration of conformity can be requested from the address given below.

When raising any technical questions, please cite the batch number (xxxxx-xx-xx-xxxxx-xxx). You will find it on the Q light fitting's type plate.

*Paul Neuhaus*

Paul Neuhaus GmbH  
Olakenweg 36 · D-59457 Werl

Telefon: +49 (0) 29 22-97 21-0  
Telefax: +49 (0) 29 22-97 21-9120  
E-mail: [info@neuhaus-group.de](mailto:info@neuhaus-group.de)  
[www.neuhaus-group.de](http://www.neuhaus-group.de)