

### 3 | Fernbedienung anlernen/ teach remote control

Siehe Q-Fernbedienungsanleitung  
See Q-remote control manual

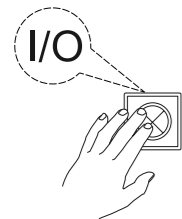

5 Leuchte einschalten  
Switch on the lamp

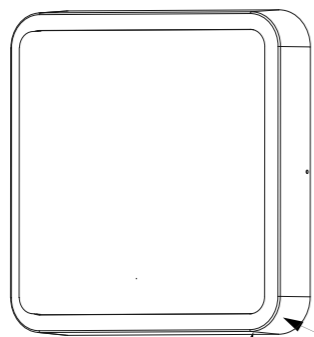

Q-Empfänger (Antenne)  
Q-receiver

7 Q-Fernbedienung anlernen  
Teach Q-Remote control

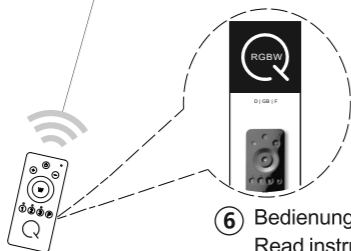

6 Bedienungsanleitung lesen  
Read instruction manual

### ! Reset

Rückstellen der Leuchte auf Werkseinstellung  
Reset the lamp, factory new

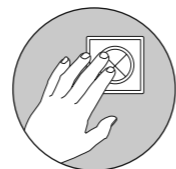

5 x on/off

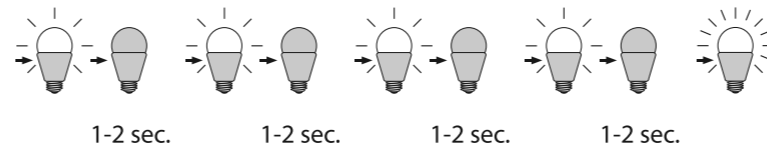

Das Gerät erfüllt die grundlegenden Anforderungen der Richtlinie 2014/53/EU (Radio Equipment Directive) des Europäischen Parlaments und des Rates der europäischen Union vom 16.04.2014 über Funkanlagen.  
Die vollständige Konformitätserklärung kann bei der unten stehenden Internet-Adresse aufgerufen werden.

This device fulfils the fundamental requirements of Directive 2014/53/EU (Radio Equipment Directive) of the European Parliament and of the Council of the European Union dated 16.04.2014 on items of radio equipment.  
The full declaration of conformity can be accessed at the Internet-address given below.

*Paul Neuhaus*

Paul Neuhaus GmbH  
Olakenweg 36 · D-59457 Werl

Telefon: +49 (0) 2922-9721-0  
Telefax: +49 (0) 2922-9721-9120  
E-mail: [kundenservice@neuhaus-group.de](mailto:kundenservice@neuhaus-group.de)  
<https://scm.paul-neuhaus.de/public/conformity/>

 SMART  
HOME  
LIGHTS

D | Montageanleitung GB | Fitting instructions

# 831238

230V / 50 Hz ~  
1 x 18 W LED-Board  
nicht wechselbar / not changeable



18 W  
2.200 lm  
21 W  
1.200 lm  
t  
25.000 h  
T<sub>k</sub>  
3.000 K / RGBW  
15.000 x  
<0,5 s



t

T<sub>k</sub>

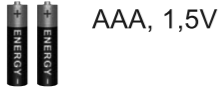
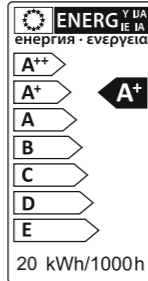

AAA, 1,5V

Inkl. Funkfernbedienung  
Incl. radio remote control



## 1 | Montage / fitting

Als Deckenleuchte  
As ceiling light

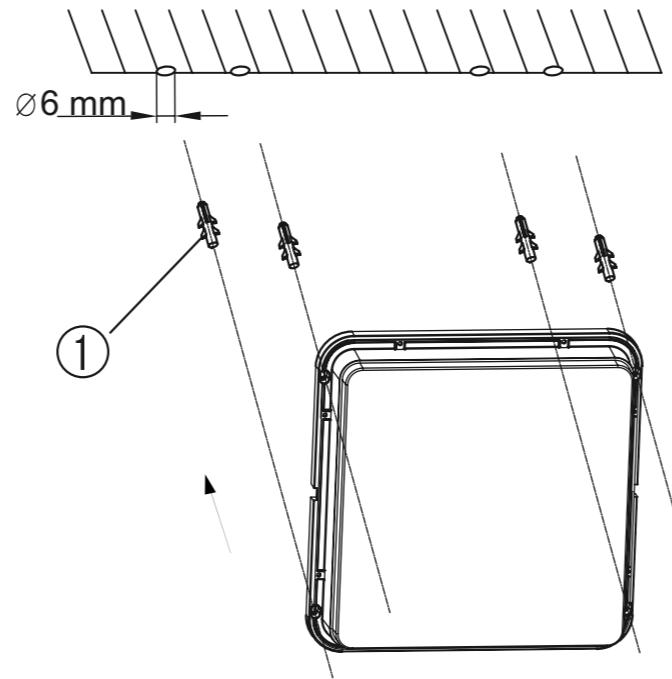

## 2 | Elektrischer Anschluss / electrical connection

230 Volt / 50Hz-Anschluss  
230 Voltage / 50Hz connection

